

Milling

NOMENCLATURE

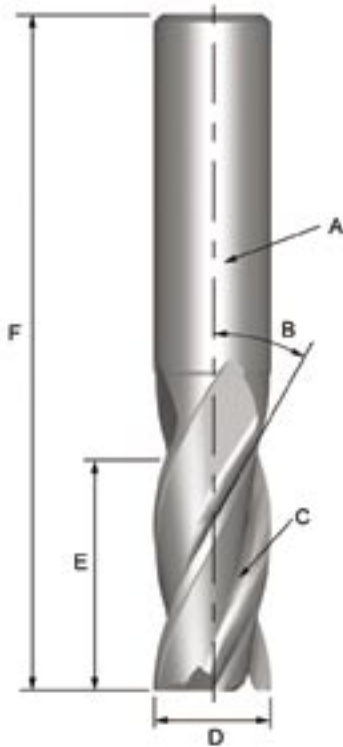

- A Shank
- B Helix Angle
- C Flute
- D Outside Diameter
- E Cutting Length
- F Overall Length

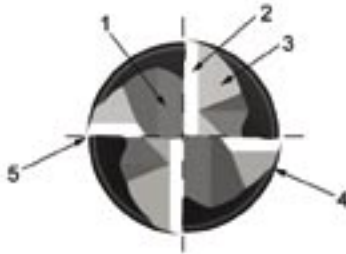

- 1 Gash
- 2 Primary Relief Angle
- 3 Secondary Relief Angle
- 4 Heel
- 5 Cutting Edge

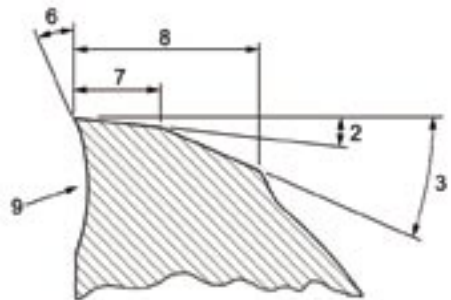

- 6 Rake Angle
- 7 Width of Primary Relief Land
- 8 Width of Secondary Relief Land
- 9 Undercut Face

GENERAL HINTS ON MILLING

Milling is a process of generating machined surfaces by progressively removing a predetermined amount of material or stock from the workpiece at a relatively slow rate of movement or feed by a milling cutter rotating at a comparatively high speed. The characteristic feature of the milling process is that each milling cutter tooth removes its share of the stock in the form of small individual chips.

TYPE OF MILLING CUTTERS

The three basic milling operations are shown below: (A) peripheral milling, (B) face milling and (C) end milling.







In peripheral milling (also called slab milling), the axis of cutter rotation is parallel to the workpiece surface to be machined. The cutter has a number of teeth along its circumference, each tooth acting like a single-point cutting tool called a plain mill. Cutters used in peripheral milling may have straight or helical teeth generating an orthogonal or oblique cutting action.

In face milling, the cutter is mounted on a spindle with an axis of rotation perpendicular to the workpiece surface. The milled surface results from the action of cutting edges located on the periphery and face of the cutter.





In end milling, the cutter generally rotates on an axis vertical to the workpiece. It can be tilted to machine tapered surfaces. Cutting teeth are located on both the end face of the cutter and the periphery of the cutter body.

Milling

PERIPHERAL AND FACE MILLING CUTTERS

Shell End Mills	Side and Face Cutters	Single and Double Angle Cutters	
			
<p>Has peripheral cutting edge plus face cutting edges on one face. It has a keyway through it to secure it to the spindle.</p>	<p>Has a cutting edge on the sides as well as on the periphery. The teeth are staggered so that every other tooth cuts on a given side of the slot. This allows deep, heavy duty cuts to be taken.</p>	<p>On angle cutters, the peripheral cutting edges lie on a cone rather than on a cylinder. A single or double angle may be created.</p>	

END MILLING CUTTERS

Flat End Mills	Ball-nose End Mills	Corner Radius End Mill	Miniature Cutters
			
<p>This end mill has a square angle at the end of the mill.</p>	<p>The shape of the end mill is a hemisphere.</p>	<p>This end mill has a small radius instead of the square end.</p>	<p>End Mills with cutting diameter up to 1 mm</p>

SELECTING THE END MILL AND THE MILLING PARAMETERS

Before any milling job is attempted, several decisions must be made to determine:

- the most appropriate end mill to be used
- the correct cutting speed and feed rate to provide good balance between rapid metal removal and long tool life.

Determining the most appropriate end mill:



- identify the type of the end milling to be carried out:-
 1. type of end mill
 2. type of centre.
- consider the condition and the age of the machine tool.
- select the best end mill dimensions in order to minimize the deflection and bending stress:-
 1. the highest rigidity
 2. the largest mill diameter
 3. avoid excessive overhang of tool from tool holder.
- choose the number of flutes
 1. more flutes – decreased space for chips – increased rigidity – allows faster table feed
 2. less flutes – increased space for chips – decreased rigidity – easy chip ejection.

Determining the correct cutting speed and feed rate can only be done when the following factors are known:

- type of material to be machined
- end mill material
- power available at the spindle
- type of finish.

FEATURES OF THE END MILL – END CUTTING EDGES

End cutting edges are divided into:

Centre Cutting Type	Non-Centre Cutting Type
	
<p>Allows drilling and plunging operations.</p> <p>Two edges reach the centre in the case of an even number of flutes (i.e. 2-4-6, etc). Only one edge in the case of an odd number (i.e. 3-5, etc).</p>	<p>Used only for profiling and open slotting.</p> <p>Allows the regrinding between centres.</p>

Milling

FEATURES OF THE END MILL - CHOOSING THE NUMBER OF FLUTES

Number of flutes should be determined by:

- Milled material
- Dimension of workpiece
- Milling conditions

	2 Flutes	3 Flutes	4 Flutes (or multiflutes)
Flexural strength	Low		High
Chip space	Big		Small
	<ul style="list-style-type: none"> • Large chip space. • Easy chip ejection. • Good for slot milling. • Good for heavy duty milling. • Less rigidity due to small section area. • Lower quality surface finish. 	<ul style="list-style-type: none"> • Chip space almost as large as for 2 flutes. • Larger section area – higher rigidity than 2 flutes. • Improved surface finish. 	<ul style="list-style-type: none"> • Highest rigidity. • Largest section area – small chip space. • Gives best surface finish. • Recommended for profiling, side milling and shallow slotting.

FEATURES OF THE END MILL – HELIX ANGLE

Increasing the number of flutes makes the load on the single tooth more homogeneous and consequently, this allows for a better finish. But with a high helix angle, the load (FV) along the cutter axis is increased too. A high FV can give:

- Load problems on the bearings
- Cutter movement along the spindle axis. To avoid this problem it is necessary to use Weldon or screwed shanks.



FEATURES OF THE END MILL – CUTTER TYPE

The DIN 1836 defines the different types of cutter profiles:

	Cutter type for steel, low to high resistance.
	Cutter type for soft malleable materials.

The DIN 1836 also defines the chip breakers:

	Coarse pitch rounded profile chip breaker Suitable for heavy duty cutting on steels and non-ferrous materials with tensile strength up to 800 N/mm ² .
	Fine pitch rounded profile chip breaker Suitable for rough milling on hard steels and non-ferrous with tensile strength more than 800 N/mm ² .
	Semi-finishing chip breaker Suitable for the roughing of light alloys and for the semi-finishing of steels and non-ferrous materials.
	Coarse pitch flat profile chip breaker Has the same application as the NR, obtaining, however, a good finishing surface and for this reason, it is placed between roughing and finishing, also called semi-finishing.

Dormer has introduced two types of roughing cutters, with **asymmetrical chip breaker**:

	Fine pitch asymmetrical rounded profile chip breaker. The asymmetry of the chip breaker reduces vibration and increases tool life.
	Coarse pitch asymmetrical rounded profile chip breaker. The asymmetry of the chip breaker reduces vibration and increases tool life.

END MILLING TYPES

There are many different operations that come under the term “end milling”. For each operation, there is an optimal cutter type. Three parameters influence the choice of the type of cutter:

- Direction of use of the cutter
- MRR (Material Removal Rate)
- Application

Milling

DIRECTION OF USE OF THE CUTTER

We can split the range of the cutters in relationship to the possible working directions to the workpiece surface. There are three different types:

3 Directions	2 Directions	1 Direction

Please note that the axial direction is possible only with centre cutting end mills.

MRR (MATERIAL REMOVAL RATE) Q

We can calculate material removal rate Q as the volume of material removed divided by the time taken to cut. The volume removed is the initial volume of the workpiece minus the final volume. The cutting time is the time needed for the tool to move through the length of the workpiece. This parameter strongly influences the finishing grade of the workpiece.

$$Q = \frac{a_p * a_e * v_f}{1000}$$

Q = MRR (cm³/min)

a_e = radial depth (mm)

a_p = axial depth (mm)

v_f = feed rate mm/min

APPLICATIONS

The MRR and the applications are strongly related. For each different application we have a different MRR that increases with the engagement section of the cutter on the workpiece. The recent Dormer Catalogue was produced with simple icons that show the different applications.

Side Milling	Face Milling	Slot Milling	Plunge Milling	Ramping
The radial depth of cut should be less than 0.25 of the diameter of the end mill.	The radial depth of cut should be no more than 0.9 of the diameter, axial depth of cut less than 0.1 of the diameter.	Machining of a slot for keyways. The radial depth of cut is equal to the diameter on the end mill.	It is possible to drill the work-piece with an end mill only with the cutting centre. In this operation the feed has to be halved.	Both axial and radial entering into the workpiece.



P9 Slotting

It is important to underline the capacity to make slots with P9 tolerance (please see the table on page 29 of General Information). Our cutters capable of slotting to this tolerance have the P9 icon.

MILLING – CONVENTIONAL VS CLIMB

The cutting action occurs either by conventional milling or climb milling.

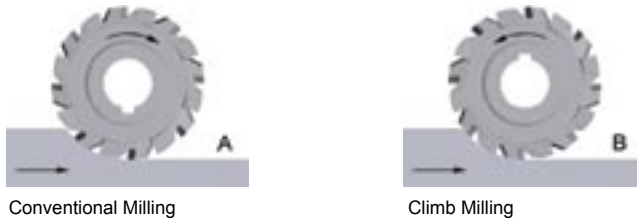

CONVENTIONAL MILLING

In conventional milling, also called *up milling*, the maximum chip thickness is at the end of the cut. The feed movement is opposite to the tool rotation.

Pros:

- Tooth engagement is not a function of workpiece surface characteristics.
- Contamination or scale on the surface does not affect tool life.
- The cutting process is smooth, provided that the cutter teeth are sharp.

Cons:

- The tool has the tendency to chatter.
- The workpiece has the tendency to be pulled up, thus proper clamping is important.
- Faster wear on tool than climb milling.
- Chips fall in front of the cutter – chip disposal difficult.
- Upward force tends to lift up workpiece.
- More power required due to increased friction caused by the chip beginning at the minimum width.
- Surface finish marred due to the chips being carried upward by tooth.

Milling

CLIMB MILLING

In climb milling, also called *down milling*, cutting starts with the chip at its thickest location. The feed movement and the tool rotation have the same direction.

Pros:

- The downward component of cutting forces holds the workpiece in place, particularly for slender parts.
- Easier chip disposal - chips removed behind cutter.
- Less wear - increases tool life up to 50%.
- Improved surface finish - chips less likely to be carried by the tooth.
- Less power required - cutter with high rake angle can be used.
- Climb milling exerts a downward force on workpiece - fixtures simple and less costly.

Cons:

- Because of the resulting high impact forces when the teeth engage the workpiece, this operation must have a rigid setup, and backlash must be eliminated in the table feed mechanism.
- Climb milling is not suitable for machining workpieces having surface scale, such as hot-worked metals, forgings and castings. The scale is hard and abrasive and causes excessive wear and damage to the cutter teeth, thus reducing tool life.

BALL NOSE END MILLS

A ball nose end mill, also known as a spherical end mill or ball end mill, has a semi-sphere at the tool end. Ball nose end mills are used extensively in the machining of dies, moulds, and on workpieces with complex surfaces in the automotive, aerospace, and defence industries.

Effective diameter is the main factor used in the calculation of the required spindle speed. Effective diameter is defined as the actual diameter of the cutter at the axial depth-of-cut line. The effective diameter is affected by two parameters: tool radius and axial depth of cut.

$$D_E = 2 * \sqrt{R^2 - (R - A_p)^2}$$

D_E = Effective diameter

R = Tool radius

A_p = Axial depth of cut

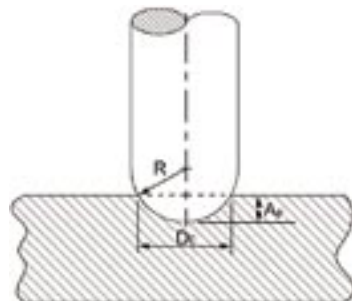

The effective diameter replaces the cutter diameter when calculating the effective cutting speed V_c for ball nose end milling. The formula becomes:

$$V_c = \frac{\pi * D_E * n}{1000}$$

V_c = Cutting speed (m/min)

D_E = Effective diameter (mm)

n = Rotation speed (rpm)

When a cutter with a non-flat end, such as a ball nose end mill, is used to cut a surface in a zigzag pattern, an uncut strip is created between the two cutting passes. The height of these undesirable strips is called cusp height.

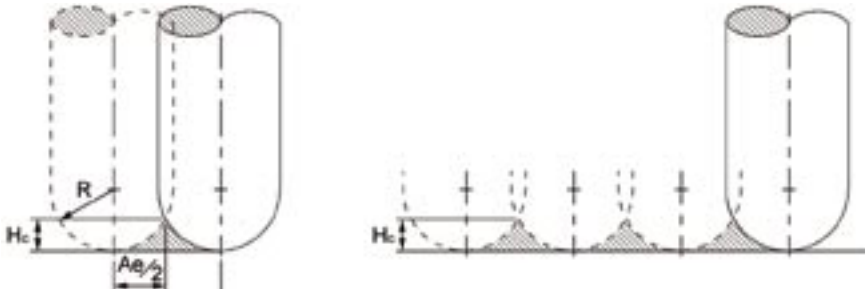

The cusp height can be calculated from

$$H_c = R - \sqrt{R^2 - \left(\frac{Ae}{2}\right)^2}$$

OR

$$Ae = 2 \sqrt{R^2 - (R - H_c)^2}$$

H_c = Cusp height

R = Tool nose radius

Ae = Step over value between two cutting passes

The correlation between H_c and R_A (surface roughness) is approximately:

H_c (μm)	0,2	0,4	0,7	1,25	2,2	4	8	12,5	25	32	50	63	100
R_A (μm)	0,03	0,05	0,1	0,2	0,4	0,8	1,6	3,2	6,3	8	12,5	16	25

R_A is appr. 25 % of H_c

Milling

BALL NOSE END MILLS IN HARDENED STEEL

The following guidelines can be used for axial depth when machining hardened steel.

Hardness (HRC)	Axial depth = A_p
$30 \leq 40$	$0,10 \times D$
$40 \leq 50$	$0,05 \times D$
$50 \leq 60$	$0,04 \times D$

HIGH SPEED MACHINING

High Speed Machining (HSM) may be defined in various ways. With regard to attainable cutting speeds, it is suggested that operating at cutting speeds significantly higher than those typically utilised for a particular material may be termed HSM.

A = HSM Range, B = Transition Range, C = Normal Range

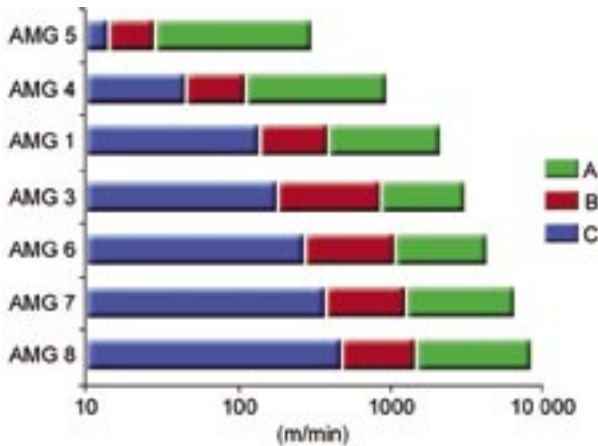

DEFINITION OF HSM

At a certain cutting speed (5-10 times higher than in conventional machining), the chip removal temperature at the cutting edge starts to decrease.

ADVANTAGES OF HSM

- | | |
|---|--|
| <ul style="list-style-type: none"> • Increased utilisation of the machine tool • Improved part quality • Reduced machining time • Decreased manpower • Reduced costs • Low tool temperature • Minimal tool wear at high speeds • Use of fewer tools | <ul style="list-style-type: none"> • Cutting forces are low (due to reduced chip load) • Low power and stiffness requirements • Smaller deflection of tools • Improved accuracy and finish obtainable • Ability to machine thin webs • Reduced process sequence time • Possibility of higher stability in cutting against chatter vibration cutting force |
|---|--|

MILLING STRATEGIES

FEED CORRECTION WHEN MILLING INSIDE AND OUTSIDE CONTOURS

Inside contour	Outside contour
$v_f prog = v_f * \frac{R2 - R}{R2}$	$v_f prog = v_f * \frac{R2 + R}{R2}$
<p>A = Path followed on workpiece B = Movement of centre point of mill R = Mill radius R1 = Radius for the mills movement path R2 = Radius to be milled on workpiece</p>	

Important: Some machine control systems have automatic correction, M-function.

RAMP-TYPE FEEDING

Recommendation for maximum ramping angle (α) for HM end mills.

Number of teeth on end mill	2	3	≥ 4
For steel and cast iron	≤ 15	≤ 10	≤ 5
For aluminium, copper and plastics	≤ 30	≤ 20	≤ 10
For hardened steel	≤ 4	≤ 3	≤ 2



Milling

SPIRAL-TYPE FEEDING

Recommendation for spiral type feeding in different materials.

Material	Recommended a_p
Steel	$< 0,10 \times D$
Aluminium	$< 0,20 \times D$
Hardened steel	$< 0,05 \times D$

$$D_{b_{max}} = 2 * (D - R)$$

$D_{b_{max}}$ = Maximum possible bore diameter

D = Mill diameter

R = Corner radius of the mill

Use maximum bore diameter (near $D_{b_{max}}$) for good chip evacuation.

AXIAL PLUNGING

In this operation, the feed rate has to be divided by the number of teeth. Please consider that it is not advisable to carry out axial plunging with an end mill with more than four teeth.



TROUBLE SHOOTING WHEN MILLING

Problem	Cause	Remedy
Breakage	Too high stock removal	Decrease feed per tooth
	Feed too fast	Slow down feed
	Flute length or overall length too long	Hold shank deeper, use shorter end mill
Wear	Workpiece material too hard	Check Catalogue or Selector for correct tool with higher grade material and/or proper coating
	Improper feed and speed	Check Catalogue or Selector for correct cutting parameters
	Poor chip evacuation	Reposition coolant lines
	Conventional milling	Climb milling
	Improper cutter helix	See recommendation in Catalogue/Selector for correct tool alternative
Chipping	Feed rate too high	Reduce feed rate
	Chattering	Reduce the RPM
	Low cutting speed	Increase the RPM
	Conventional milling	Climb milling
	Tool rigidity	Choose a shorter tool and/or place shank further up holder
	Workpiece rigidity	Hold workpiece tightly
Short Tool Life	Tough work material	Check Catalogue or Selector for correct tool alternative
	Improper cutting angle and primary relief	Change to correct cutting angle
	Cutter/workpiece friction	Use coated tool
Bad Surface finish	Feed too fast	Slow down to correct speed
	Speed too slow	Increase the speed
	Chip biting	Decrease stock removal
	Tool wear	Replace or regrind the tool
	Edge build up	Change to higher helix tool
Workpiece inaccuracy	Chip welding	Increase coolant quantity
	Tool deflection	Choose a shorter tool and/or place shank further up holder
	Insufficient number of flutes	Use a tool with more flutes
	Loose/worn tool holder	Repair or replace it
	Poor tool holder rigidity	Replace with shorter/more rigid tool holder
	Poor spindle rigidity	Use larger spindle
Chattering	Feed and speed too high	Correct feed and speed with the help of the Catalogue/Selector
	Flute or overall length too long	Hold shank deeper and use shorter end mill
	Cutting too deep	Decrease depth of cut
	Not enough rigidity (machine and holder)	Check the tool holder and change it if necessary
	Workpiece rigidity	Hold workpiece tightly